



**OWNER'S MANUAL**  
**800.5 EVO6**

Introduction.....	3
Package contents .....	3
Safety instructions.....	4
Panels description	
Audio inputs and controls .....	5
Power inputs and audio outputs.....	6
Installation sequence.....	7
Electrical dimensioning .....	8
Audio inputs	
RCA inputs .....	8
High Level inputs .....	9
Wiring diagram	
Two channels wiring diagram + Subwoofer .....	10
Two channel wiring diagram (in bridge) + Subwoofer.....	11
Four channels wiring diagram + Subwoofer.....	12
Wiring diagram with 4-channel routing + Subwoofer .....	13
Procedure for setting the Gain (Channels 1 to 4).....	14
Procedure for setting the Gain (Subwoofer) / SD RLC.....	15
Fixed Crossover .....	16
Battery connection diagram .....	17
Technical specifications	
Parameters .....	18
Dimensional data.....	18
Additional Information .....	18

## Dear Consumer,

Congratulations, you have just acquired a SoundDigital product of the highest technology and quality, so we thank you for your trust.

SoundDigital products are made with raw materials of the highest quality standards, and the most modern processes, equipment and technology are used in their production.

## IMPORTANT INFORMATION

On this manual you will learn about the product, its features and characteristics, in order to obtain the best result and to be able to enjoy your music with SoundDigital quality and power.

Read this manual carefully and follow precisely all the information contained therein, these are very important and allow your amplifier to work optimally. If you think it is necessary, please do not hesitate to contact our technical support at the following contact:





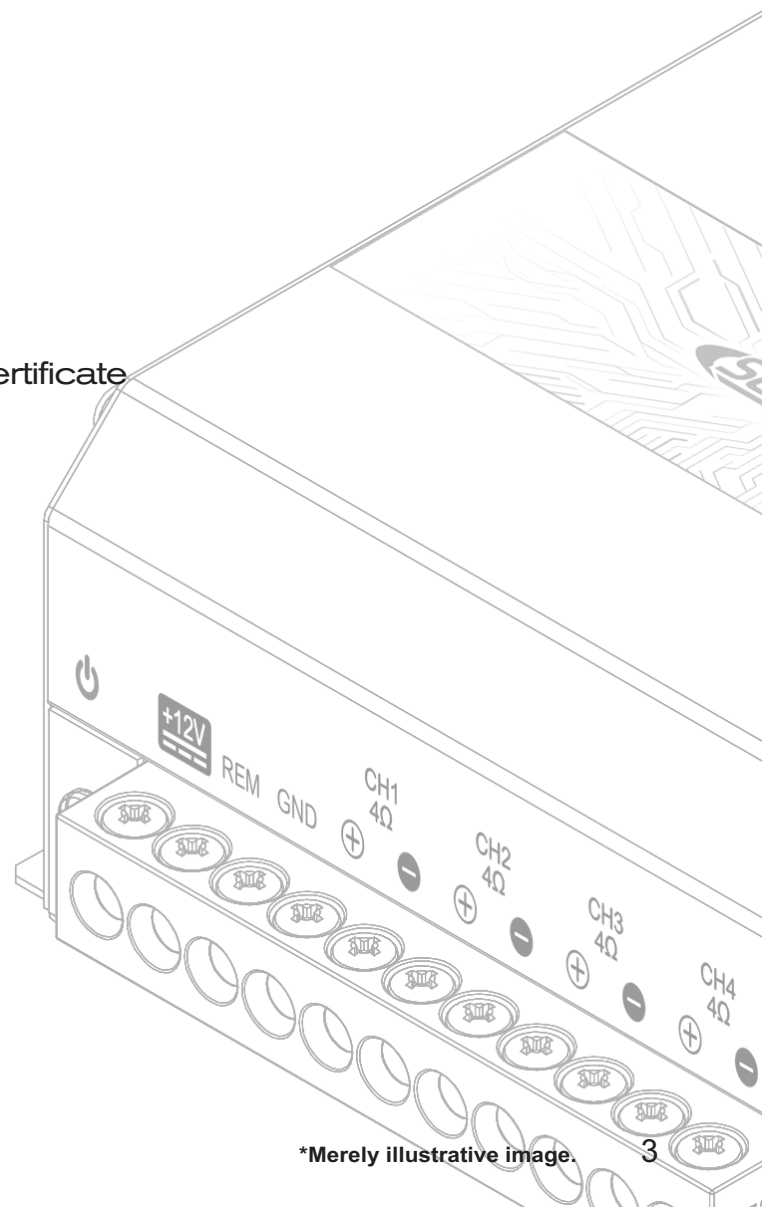

✉ [info@sounddigitalusa.com](mailto:info@sounddigitalusa.com)

## PACKAGE CONTENTS

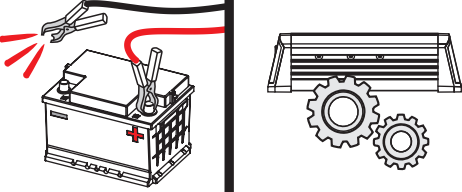
- 01 **800.5 EVO6** amplifier
- 01 Quick installation guide with warranty certificate
- 03 Cables for high level inputs

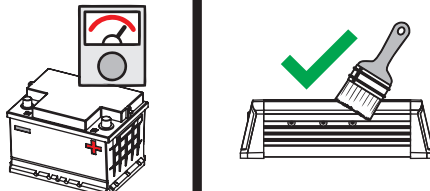

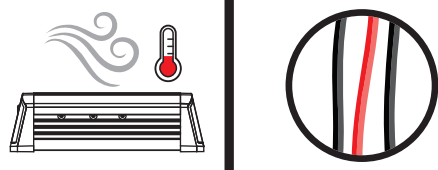
To avoid injury to the user or damage to the amplifier, read all safety instructions written on this manual.

<p>The installation of this product must be done by a qualified professional. In case of any doubt, please contact our technical support;</p>	 <p>When passing cables through metallic walls, use rubber O-rings to avoid cable cutting and short-circuits;</p>
<p>Before proceeding with the installation of any electric equipment on your vehicle, unplug the negative (-) terminal of the battery to avoid fires, injuries or damages;</p>	 <p>Make sure that the chosen location for the amplifier installation does not affect the operation of the vehicle;</p>
<p>Use your sound system safely. The continuous exposure to sound pressures over 85dB may cause irreversible hearing damage;</p>	 <p>This product may reach temperatures over 60°C (140°F). Make sure it is cold before touching it;</p>
<p>This equipment is for use in automotive DC voltage batteries between 12.6 and 14.4 volts. Before installing the equipment, check voltage of the batteries;</p>	 <p>Clean the amplifier periodically with brush or dry cloth to assure the thermal efficiency of the heatsink;</p>
<p>Do not install the amplifier in places exposed to water, dirt or humidity;</p>	 <p>Be careful when making holes in the vehicle. Make sure you are not making holes in the fuel tank, brake lines or electrical cables of the vehicle;</p>
<p>Choose a ventilated place to install the amplifier and avoid blocking the side ventilation windows;</p>	 <p>Make sure the cables are properly secured throughout the installation;</p>
<p>Fix the amplifier properly and firmly. Avoid fixing to metallic parts of the vehicle, as this procedure may cause ground looping (noise);</p>	 <p>Wear gloves, safety glasses and all necessary PPE during the installation of Soundigital amplifiers.</p>



**Warning!**

THIS "WARNING" SIGN ALERTS THE USER OF IMPORTANT INFO. NOT FOLLOWING THESE INSTRUCTIONS MAY CAUSE INJURIES TO THE USER OR DAMAGE TO THE EQUIPMENT.

## Audio inputs and controls

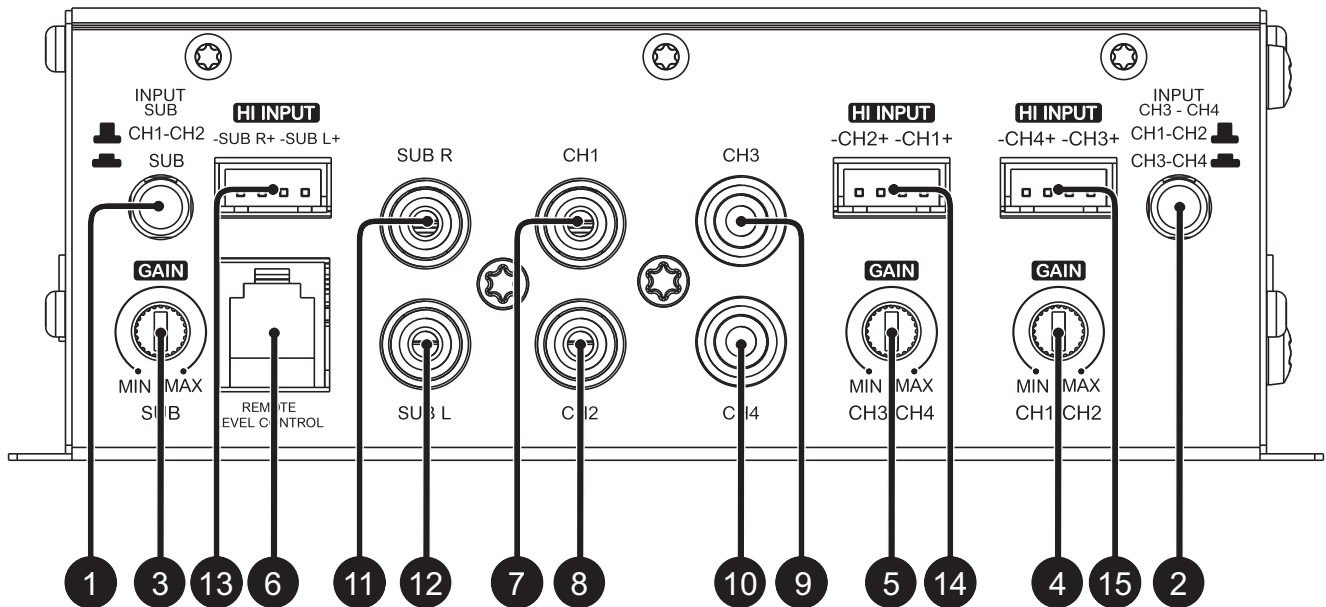

1	Subwoofer	Channel signal routing
2	Channels 3 and 4	Channel signal routing
3	Subwoofer	Variable Gain control
4	Channels 1 and 2	Variable Gain control
5	Channels 3 and 4	Variable Gain control
6	Subwoofer	Remote level control connector
7	Channel 1	Audio inputs – RCA connectors
8	Channel 2	
9	Channel 3	
10	Channel 4	
11	Right subwoofer	Audio inputs – RCA connectors
12	Left subwoofer	
13	Right and left subwoofer	Audio input – High Level (To connect to the speaker output of the head unit)
14	Channels 1 and 2	Audio input – High Level (To connect to the speaker output of the head unit)
15	Channels 3 and 4	Audio input – High Level (To connect to the speaker output of the head unit)

## Power inputs and audio outputs

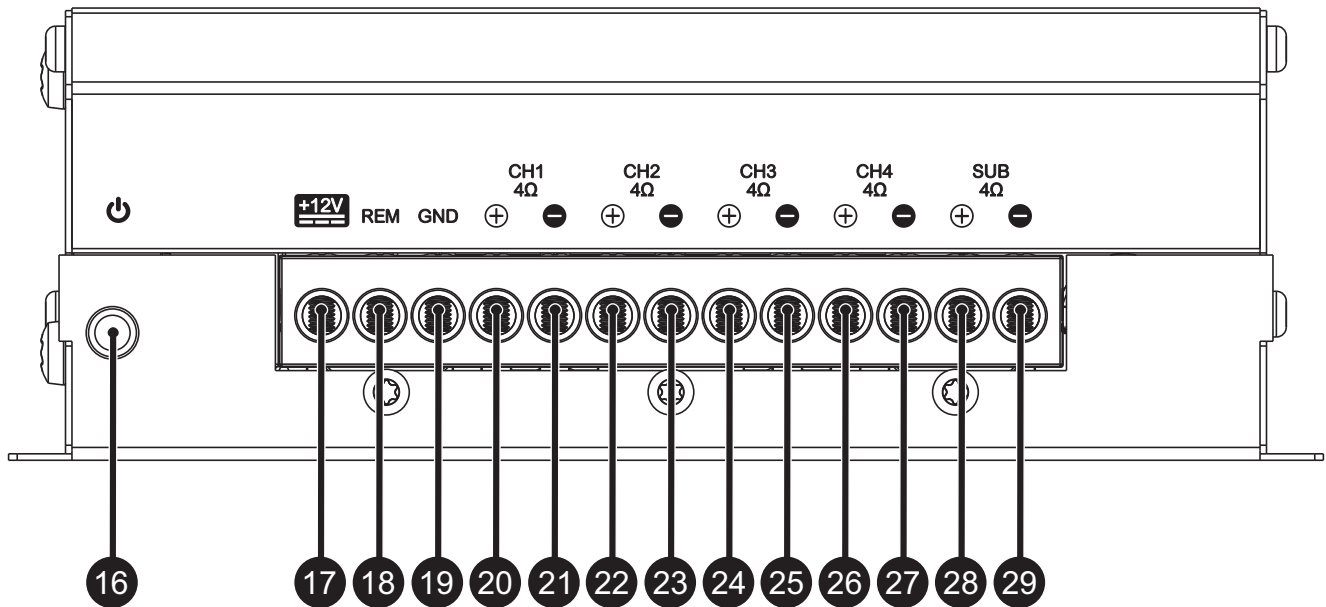

16	Blue	"POWER ON" LED indicator
17	-	Positive power supply connector (+12VDC)
18	-	Remote power supply connector (REM)
19	-	Negative power supply connector (GND)
20	Channel 1	Audio output connector positive (+)
21		Audio output connector negative (-)
22	Channel 2	Audio output connector positive (+)
23		Audio output connector negative (-)
24	Channel 3	Audio output connector positive (+)
25		Audio output connector negative (-)
26	Channel 4	Audio output connector positive (+)
27		Audio output connector negative (-)
28	Subwoofer	Audio output connector positive (+)
29		Audio output connector negative (-)



BEFORE PROCEEDING WITH THE INSTALLATION, UNPLUG THE NEGATIVE TERMINAL FROM ALL OF THE BATTERIES, TO AVOID FIRE, DAMAGE TO THE AMPLIFIER AND THE USER HIMSELF.

**Warning!**

- Fix the amplifier so that the connectors can be easily accessed;
- Install the power cables in the vehicle properly, starting from the battery to the fuse holder or circuit breaker, use the cable with the appropriate size. Make all connections, install fuse holders or circuit breakers, but without placing the fuses or with the circuit breakers in the "OFF" position;



THE MAXIMUM DISTANCE FOR THE INSTALLATION OF THE FUSE/CIRCUIT BREAKER IS 12 INCHES (30cm) AWAY FROM THE BATTERY.

**Warning!**

- Connect the power cables in to the amplifier, observing the polarity. Connect all the positive cables (+) from the fuse holder or circuit breaker to the positive conector of the amplifier and all the negative power cables from the batteries to the negative connector of the amplifier;
- The ground cable must be as short as possible and must be connected to the vehicle chassis and the battery negative;

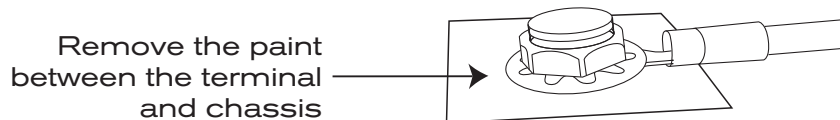

- Install the signal input cables in a proper way, distant from the power cables;
- Connect the RCA cables to the head unit and amplifiers;
- Install the audio output cables with the appropriate section, distant from the power and audio input cables;
- Connect the audio output cables to the amplifier and speakers respecting the positive (+) and negative (-) polarities;
- Install the remote cable with the power cables, using 1.5mm<sup>2</sup> (15 AWG) cable or thicker;
- Connect the remote power cable to the amplifier's "REM" terminal at the main unit's remote power output;
- Before powering the system, verify all the connections and make sure there are no mistakes or short-circuits on the power and ground cables;
- Reconnect the ground of the batteries;
- Check if the head unit is turned off and then place the fuses in the fuse holders or switch the circuit breakers on;
- Turn on the main unit and the amplifier will turn on the "POWER ON" LED indicating that it is in operation.



**Warning!**

Minimum recommended installation distance between amplifiers\*.  
1.18in. (30mm)

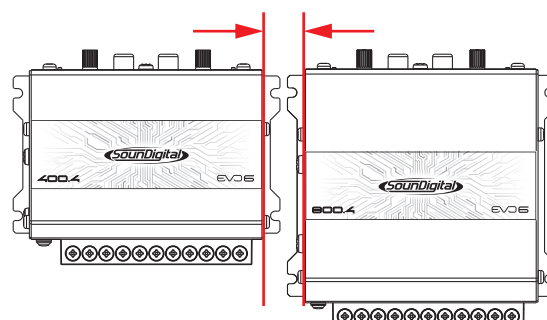

\*For installations with more than one amplifier, second unit not included. Merely illustrative images.

## ELECTRICAL DIMENSIONING

For proper operation of your SounDigital amplifier, you need the proper dimensioning of the electrical system and the cables used.

The table below shows the minimum section of GND cables, +12VDC cables and speaker output cables according to the power generated by the amplifier.

800 WRMS	POWER CABLE (+12VDC)		10mm <sup>2</sup> (7 AWG)
	GROUND CABLE (GND)		
	AUDIO OUTPUT CABLE	SPEAKER	1.5mm <sup>2</sup> (15 AWG)
		SUBWOOFER	2.5mm <sup>2</sup> (13 AWG)
REMOTE CABLE		1.5mm <sup>2</sup> (15 AWG)	

We recommend the use of only OFC (Oxygen Free Copper) cables on the installation of our products.

Copper-clad aluminum wire (CCAW) must not be used.

## AUDIO INPUTS

### RCA inputs

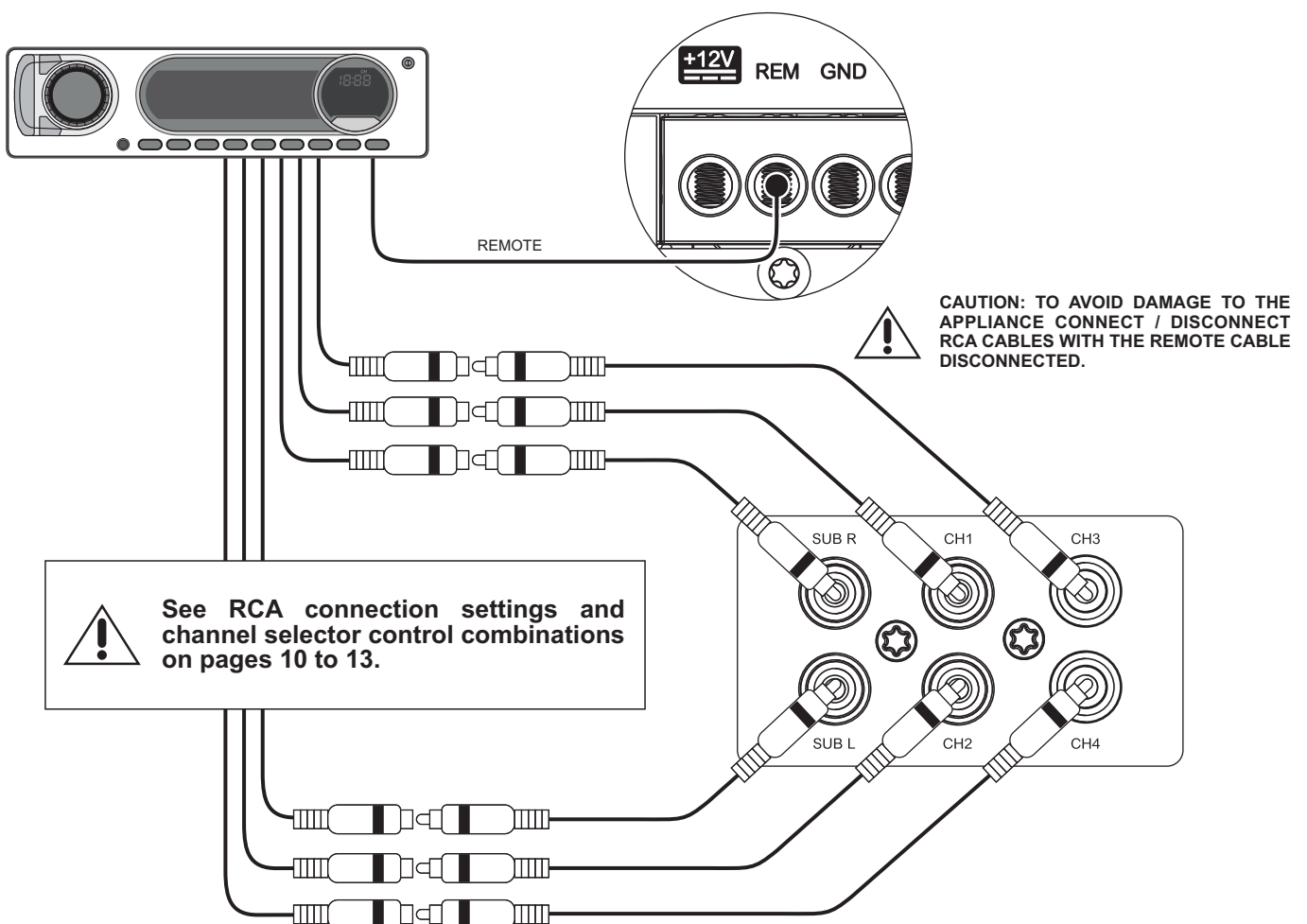



**High level signal inputs**

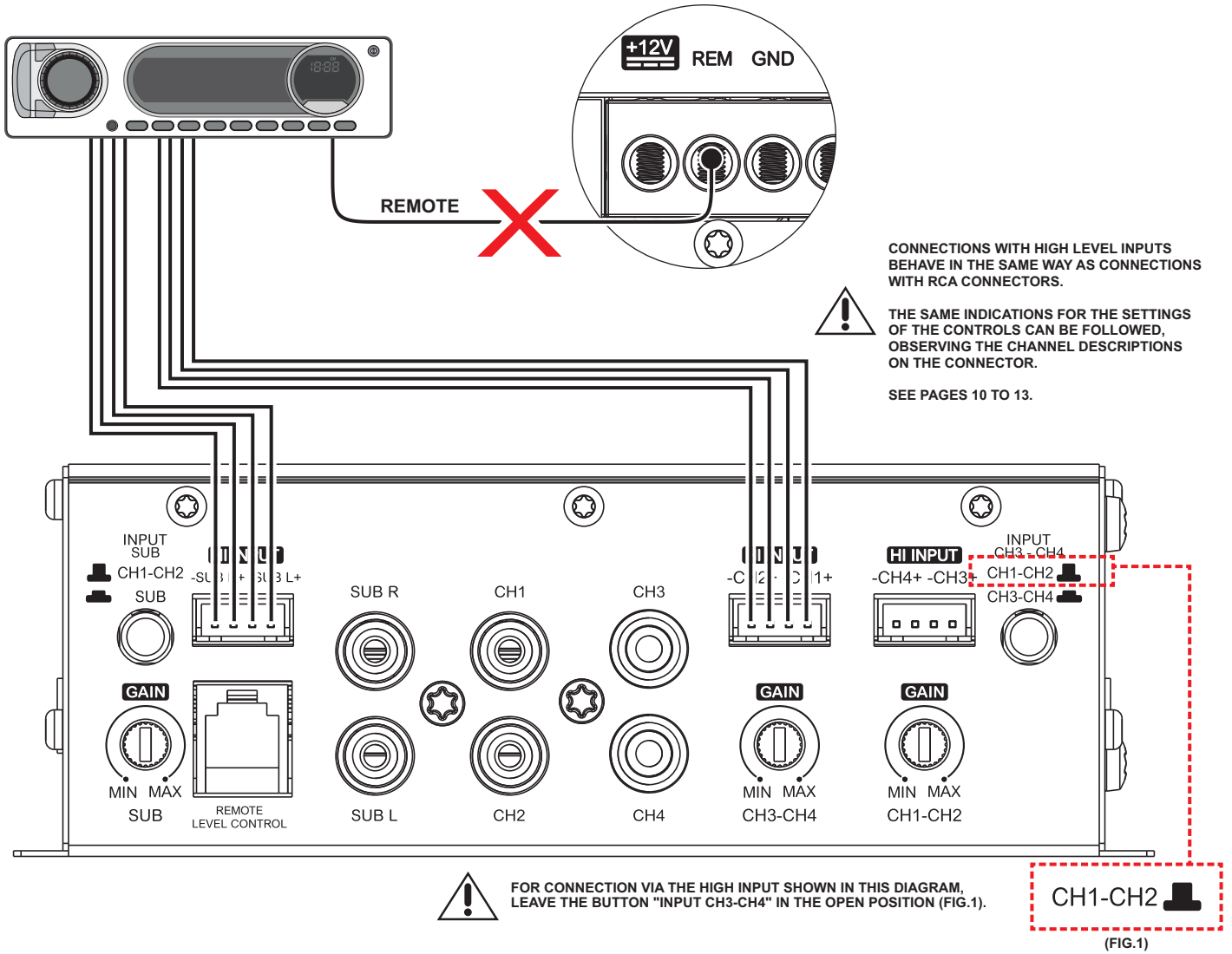

High level input must be used when the main unit does not have RCA outputs.

When High level input is used, no remote connection is required, the amplifier recognizes the audio signal and switches on.

If your source unit is not able to turn on the amplifier through the High level input, the remote input should be connected normally.



RCA AND HIGH LEVEL INPUTS SHOULD NOT BE USED SIMULTANEOUSLY OR YOU MAY DAMAGE THE AMPLIFIER.

2 CHANNELS WIRING DIAGRAM (per channel) + SUBWOOFER

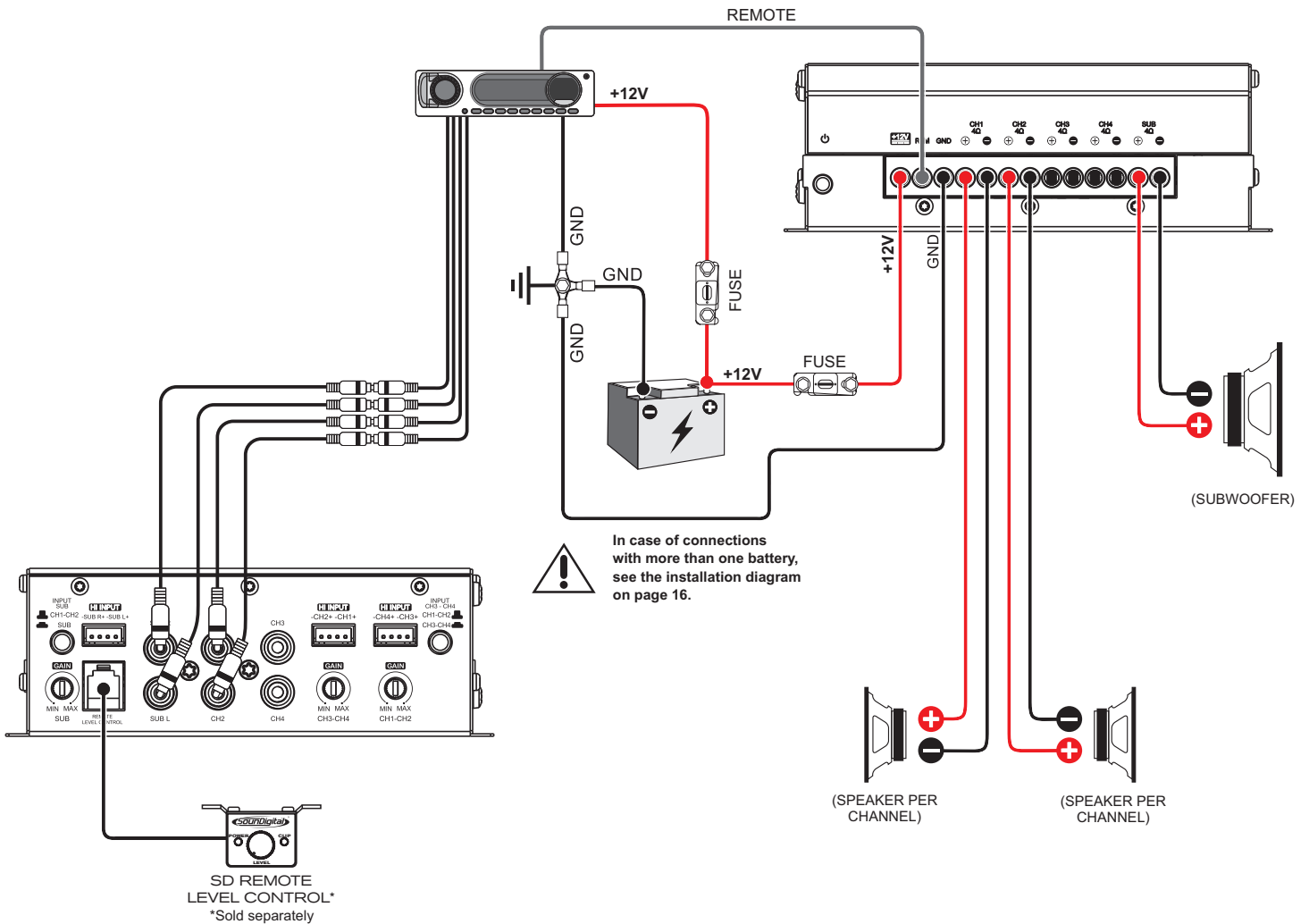
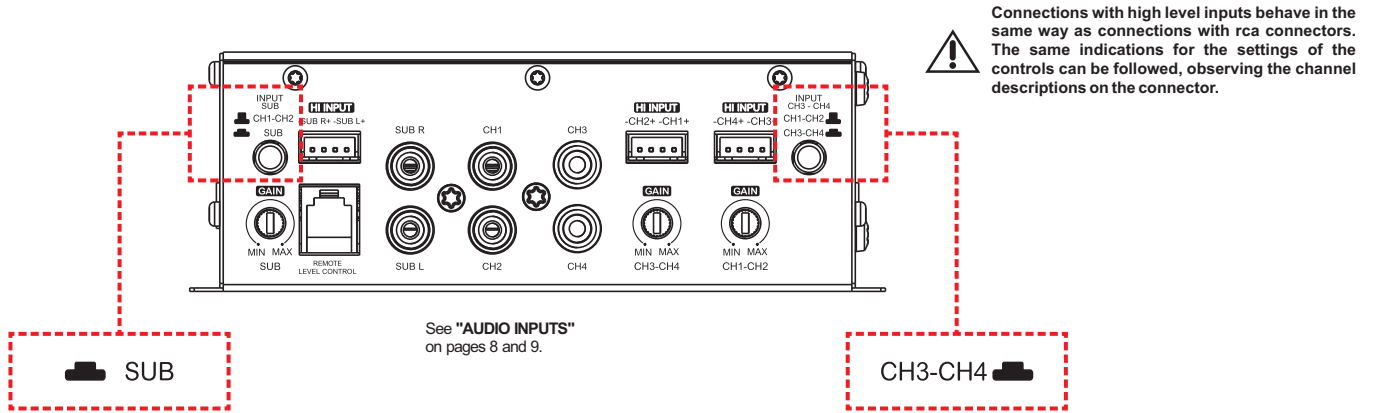

800.5 EVO6 4Ω  
Minimum impedance of use according to the model

Output	Per channel	Bridge
Channels 1 ~ 4	4Ω	8Ω
Subwoofer	4Ω	N/A

2 CHANNELS WIRING DIAGRAM (in Bridge) + SUBWOOFER

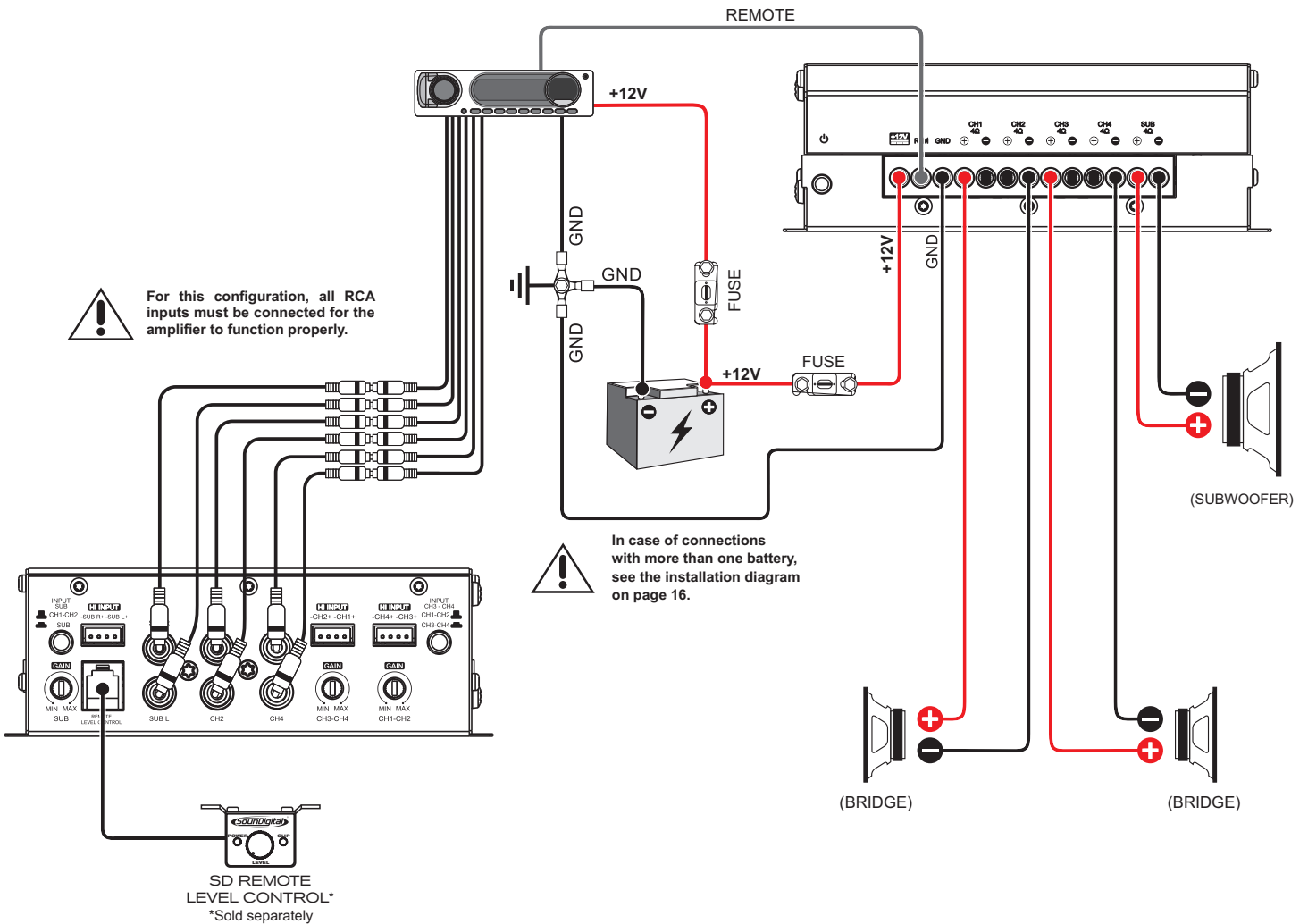
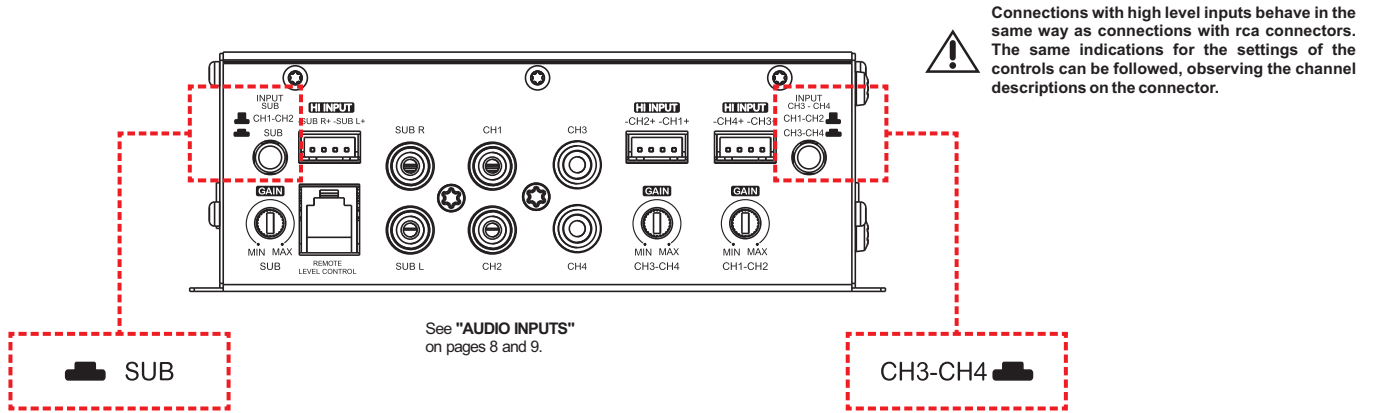

800.5 EVO6 4Ω  
Minimum impedance of use according to the model

Output	Per channel	Bridge
Channels 1 ~ 4	4Ω	8Ω
Subwoofer	4Ω	N/A

4 CHANNELS WIRING DIAGRAM (per channel) + SUBWOOFER

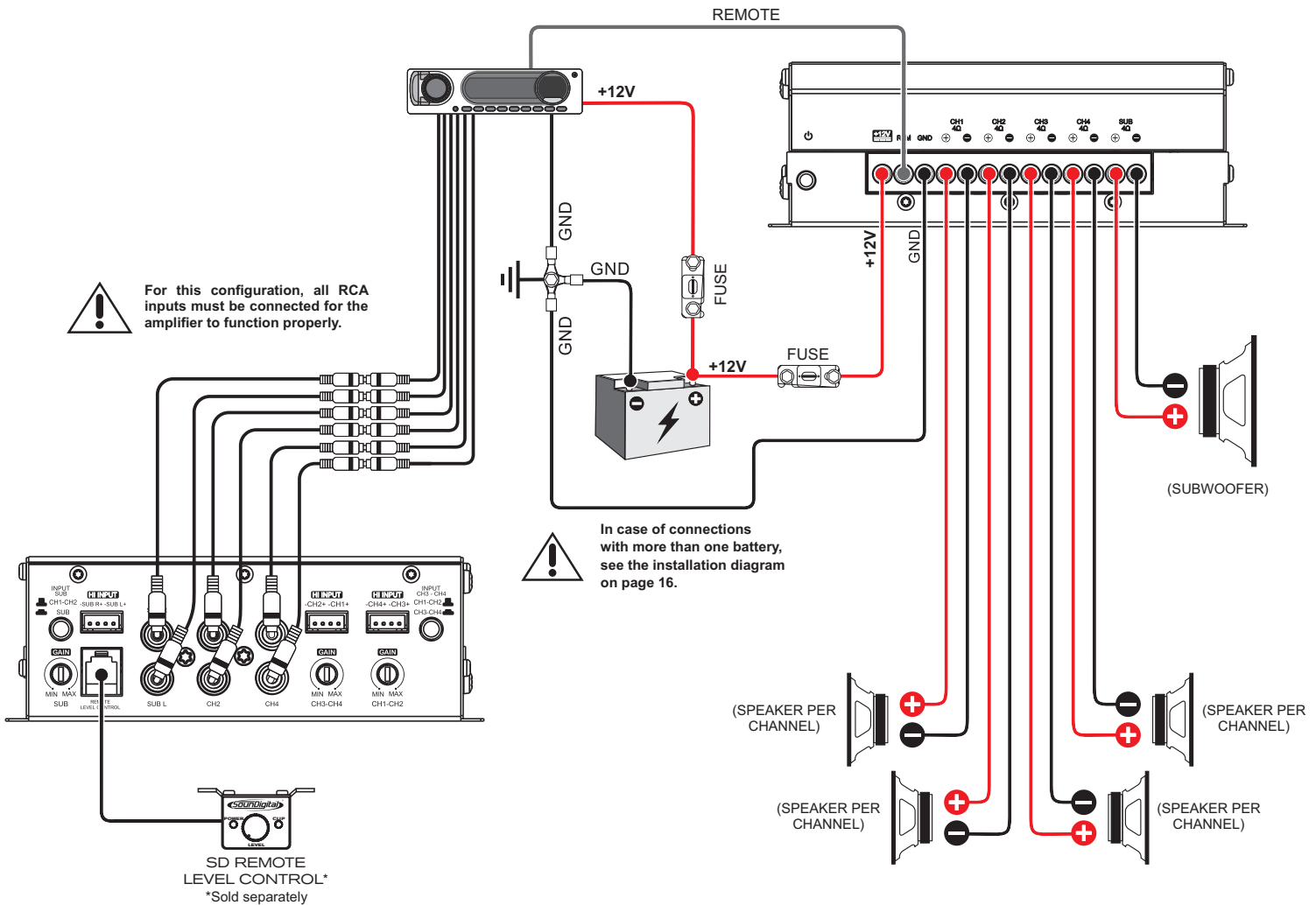
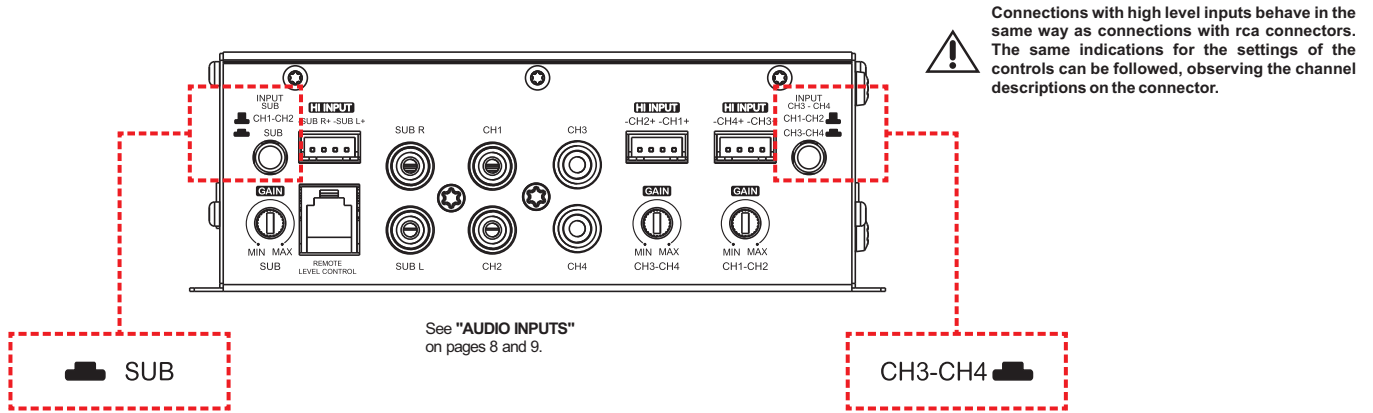

800.5 EVO6 4Ω  
Minimum impedance of use according to the model

Output	Per channel	Bridge
Channels 1 ~ 4	4Ω	8Ω
Subwoofer	4Ω	N/A

WIRING DIAGRAM WITH 4-CHANNEL ROUTING (per channel) + SUBWOOFER

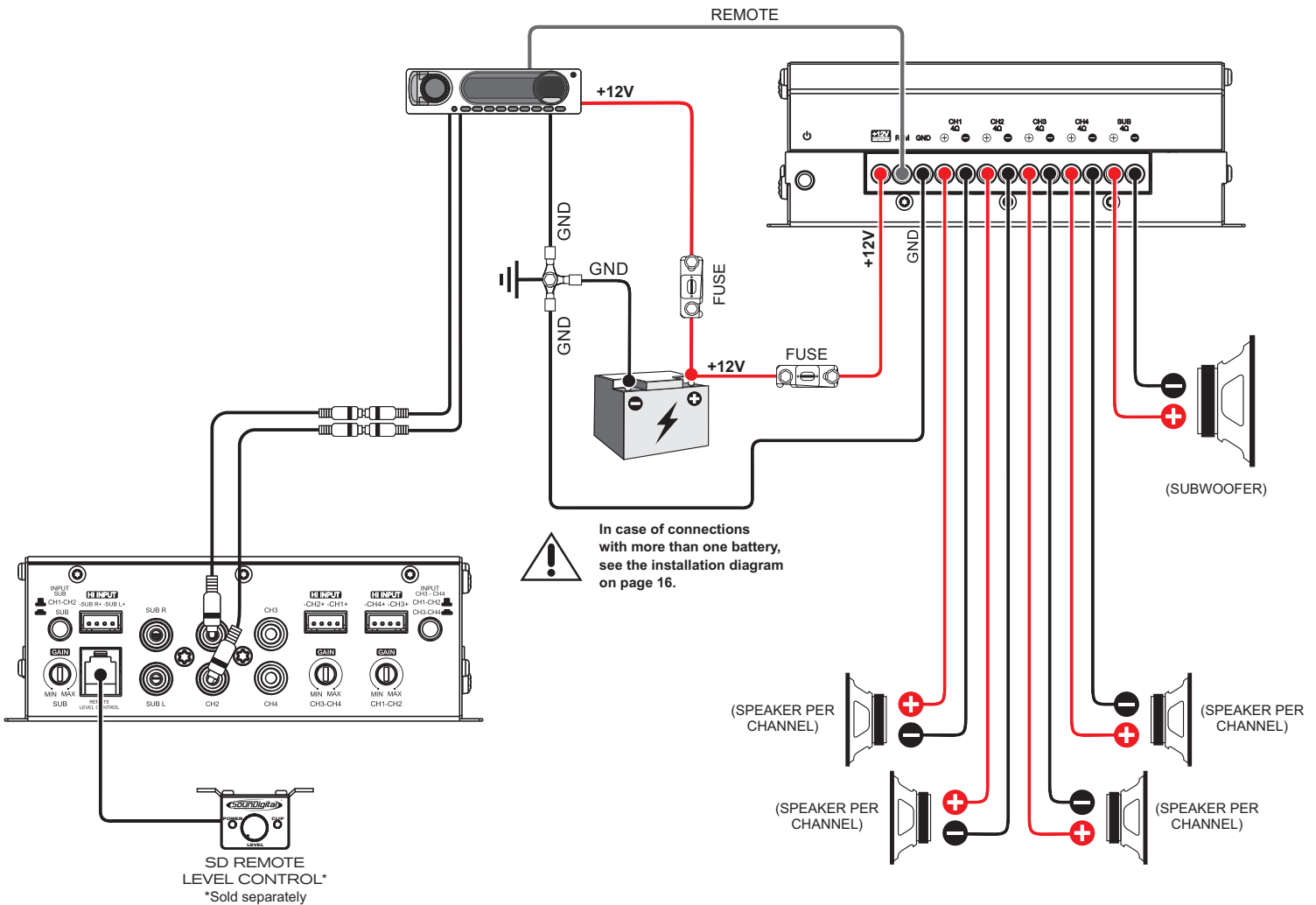
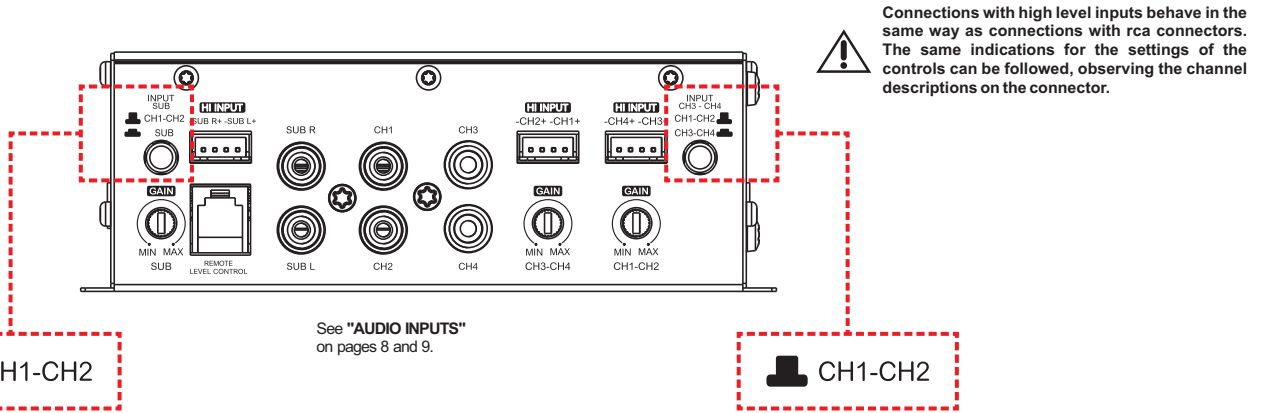

800.5 EVO6 4Ω  
Minimum impedance of use according to the model

Output	Per channel	Bridge
Channels 1 ~ 4	4Ω	8Ω
Subwoofer	4Ω	N/A



## GAIN SETTING

### Necessary equipment:

- Digital AC voltmeter;
- Media with sine wave test tone 1 kHz recorded at 0db;
- 1/8" screwdriver (for gain setting).

### Set up procedure:

- This procedure is the same for both gain controls;
- Turn the gain control all the way down;
- Disconnect the output cables from the amplifier outputs;
- Turn off all processing (bass, treble, loudness, EQ, etc.);
- Set the audio player volume to 3/4 of full volume;

- On the audio player, set the fader control to center position;
- Use a 1 kHz sine wave;
- Connect the AC voltmeter to the speaker output connectors of the amplifier. Make sure you test the voltage at the correct connectors (+ and -);
- Increase the gain control until the target voltage is observed with the voltmeter (see the chart below);
- Once you have adjusted the amplifier to the correct voltage output, turn off the source unit and reconnect the speaker(s).

MODEL	STEREO / POWER	BRIDGE / POWER	STEREO OUTPUT VOLTAGE	BRIDGE OUTPUT VOLTAGE
800.5 EVDS 4Ω	4Ω / 4 x 100W	8Ω / 2 x 200W	20V	40V

Download the tracks for set up in <https://soundigitalusa.com/tracks-for-set-up/>



## GAIN SETTING

### Necessary equipment:

- Digital AC voltmeter;
- Media with sine wave test tone 60Hz recorded at 0db;
- 1/8" screwdriver (for gain setting).
- On the audio player, set the fader control to center position;
- Use a 60Hz sine wave;

### Set up procedure:

- Turn the gain control all the way down;
- Disconnect the output cables from the amplifier outputs;
- Turn off all processing (bass, treble, loudness, EQ, etc.);
- Set the audio player volume to 3/4 of full volume;
- Connect the AC voltmeter to the speaker output connectors of the amplifier. Make sure you test the voltage at the correct connectors (+ and -);
- Increase the gain control until the target voltage is observed with the voltmeter (see the chart below);
- Once you have adjusted the amplifier to the correct voltage output, turn off the source unit and reconnect the speaker(s).

MODEL	STEREO / POWER	BRIDGE / POWER	STEREO OUTPUT VOLTAGE	BRIDGE OUTPUT VOLTAGE
800.5 EVJES 4Ω	4Ω / 1 x 400W	N/A	40V	N/A

Download the tracks for set up in <https://soundigitalusa.com/tracks-for-set-up/>

## EXTERNAL LEVEL CONTROL - SD RLC (\*Not included)

The SD RLC is an easy-to-install external level control accessory that allows you to tune the level of SOUNDIGITAL amplifiers that have remote level control.

In SD RLC, you can adjust the amplifier level without having to lean over and adjust the gain setting on the amplifier and can monitor the "CLIP" LED which is also available on the accessory.

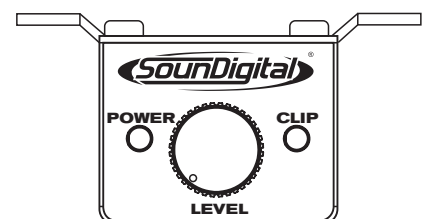

SD REMOTE LEVEL CONTROL\*

\*Sold separately

**CHANNELS 1 TO 4**

All frequencies above 80Hz will be reproduced as in the figure below.

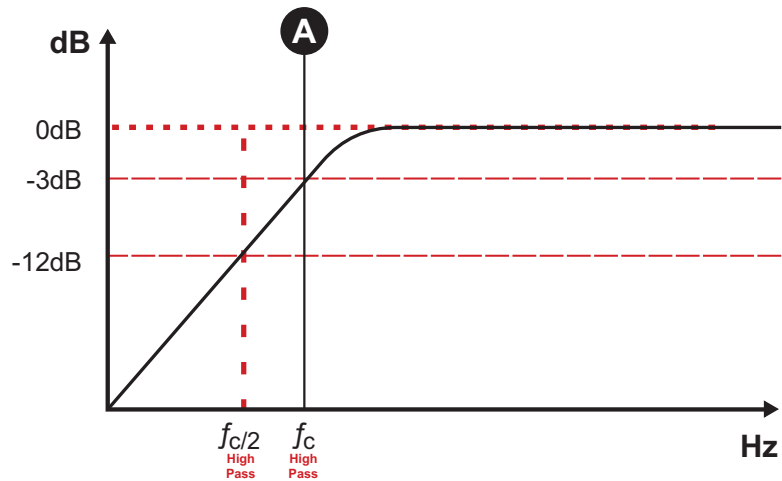
**SUBWOOFER**

All frequencies below 80Hz will be reproduced as in the figure below.

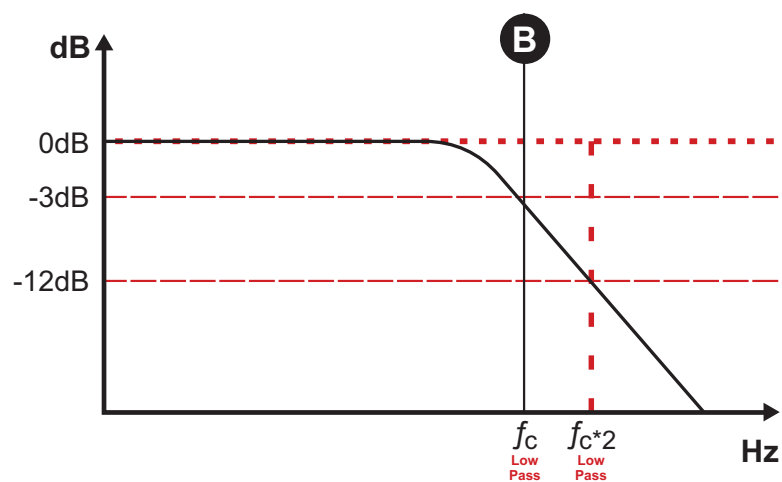



When necessary the association of one or more battery banks to supply the necessary current to the amplifier, it is recommended to use batteries of the same brand, model, and if possible the same manufacturing lot so that the system has the maximum performance.

For an ideal energy performance, we recommend that all batteries be connected to positive and negative busbars and the busbars connected to the amplifier, as shown in the diagram below:

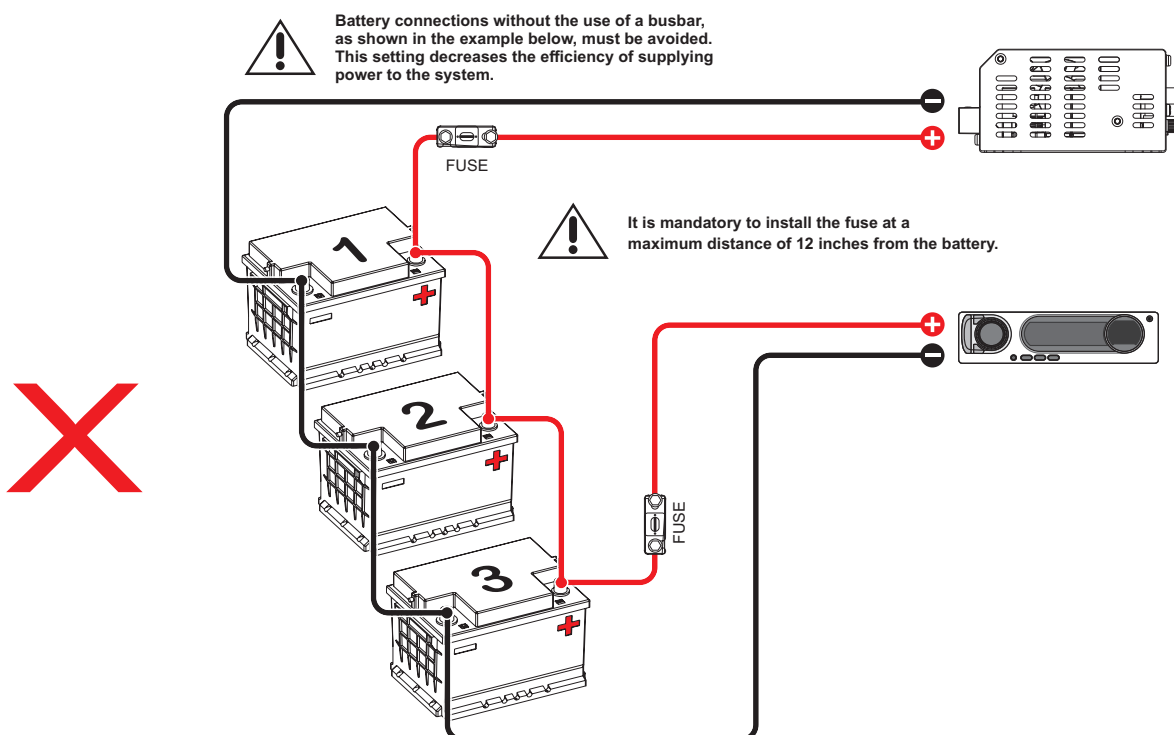
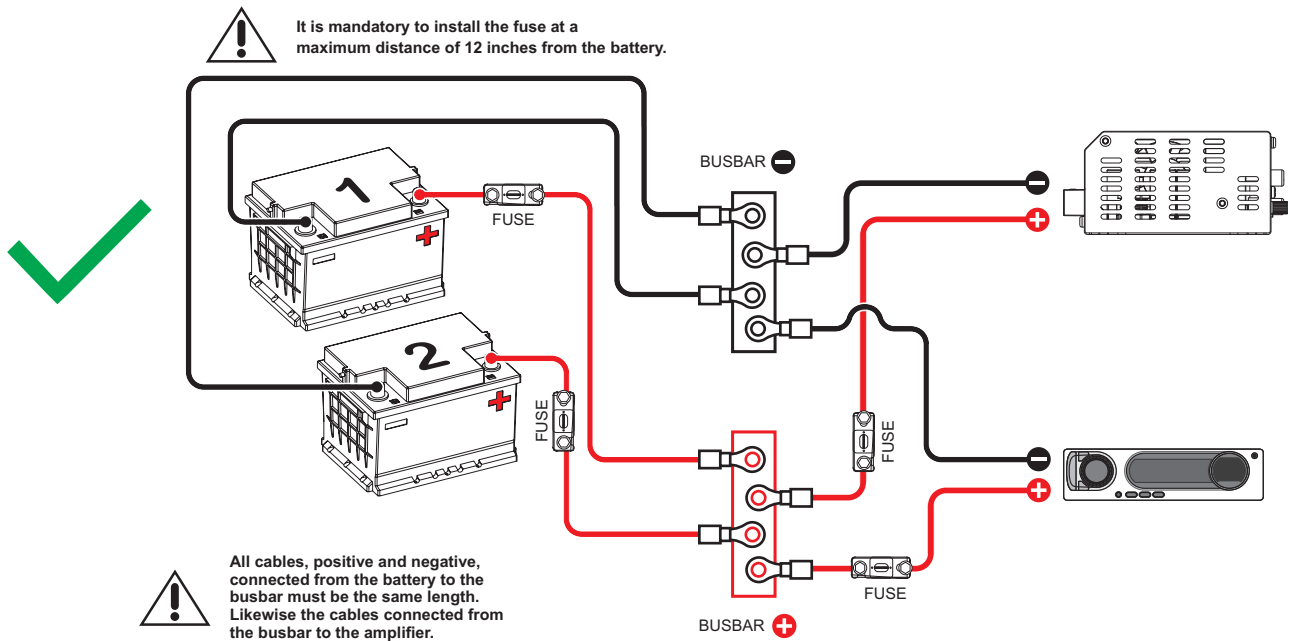

PARAMETERS   800.5 EVO6 4Ω	CHANNELS 1 ~ 4	SUBWOOFER
Power RMS @ 4Ω**	4 x 100W	1 x 400W
Power RMS (Bridge) @ 8Ω**	2 x 200W	N/A
Frequency Response (-3dB)	80Hz ~ 25kHz	5Hz ~ 80Hz
Low Pass Filter (12dB/octave)	80Hz	N/A
High Pass Filter (12dB/octave)	N/A	80Hz
Operating Voltage	9V ~ 16V	
SNR	103.88dB	102dB
Input Sensitivity (RCA)	0.2V ~ 2V	
Input Sensitivity (High Level input)	2V ~ 20V	
Current Draw (music)	39A	
Current Draw (max.)	78.7A	
Total Efficiency	80%	
Damping Factor (@100Hz nominal impedance)	200	
Power Cable	10mm <sup>2</sup> (7 AWG)	
Speaker / Subwoofer Cable	1.5mm <sup>2</sup> (15 AWG)	2.5mm <sup>2</sup> (13 AWG)
Remote Cable	1.5mm <sup>2</sup> (15 AWG)	
Recommended Fuse* (music)	40A	
Recommended Battery (minimum)	60Ah	

\*It is mandatory to install the fuse at a maximum distance of 12 inches from the battery.

\*\*Power at 12.6V @ 60Hz with a maximum THD of 1%.



**\*\*POWER RATING ACCORDING TO CTA-2006 INDUSTRY STANDARDS.**

## DIMENSIONAL DATA

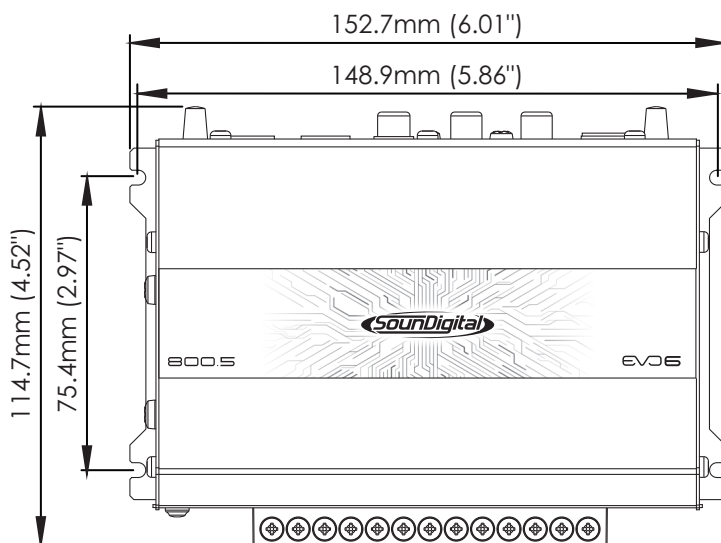

Net Weight	0.75 kg (1.65 lb)
Gross Weight	0.82 kg (1.80 lb)

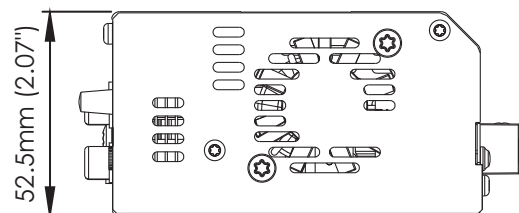

## ADDITIONAL INFORMATION

The values presented are based on measurements performed in SounDigital's laboratories. All the equipment used in the assays, tests, measurements and gauging of the technical parameters of SounDigital products were calibrated in certified laboratories, thus ensuring the performance and standard of excellence of the developed products.

The Manufacturing Process may present variations, and the electronic components may also present changes in values in relation to their nominal parameters. Thus, causing small differences between measurements taken. Small variations in the values presented and divulged by SounDigital are recognized.



Updates of information made in this document will always be published and made available for consumer consultation, free of charge, on the brand's websites. The user is advised to search for the manual in its latest version when necessary.

The images presented in this document are representative and merely illustrative; therefore, they do not necessarily correspond to the actual product/model.



Document revision code: 1000750487-005/AUG2024



Consumer  
Technology  
Association™



[WWW.SOUNDIGITALUSA.COM](http://WWW.SOUNDIGITALUSA.COM)



[SOUNDIGITALUSA](https://www.facebook.com/SOUNDIGITALUSA)



[SOUNDIGITALUSA](https://www.instagram.com/SOUNDIGITALUSA)